

SPINNING REEL — RS1355A

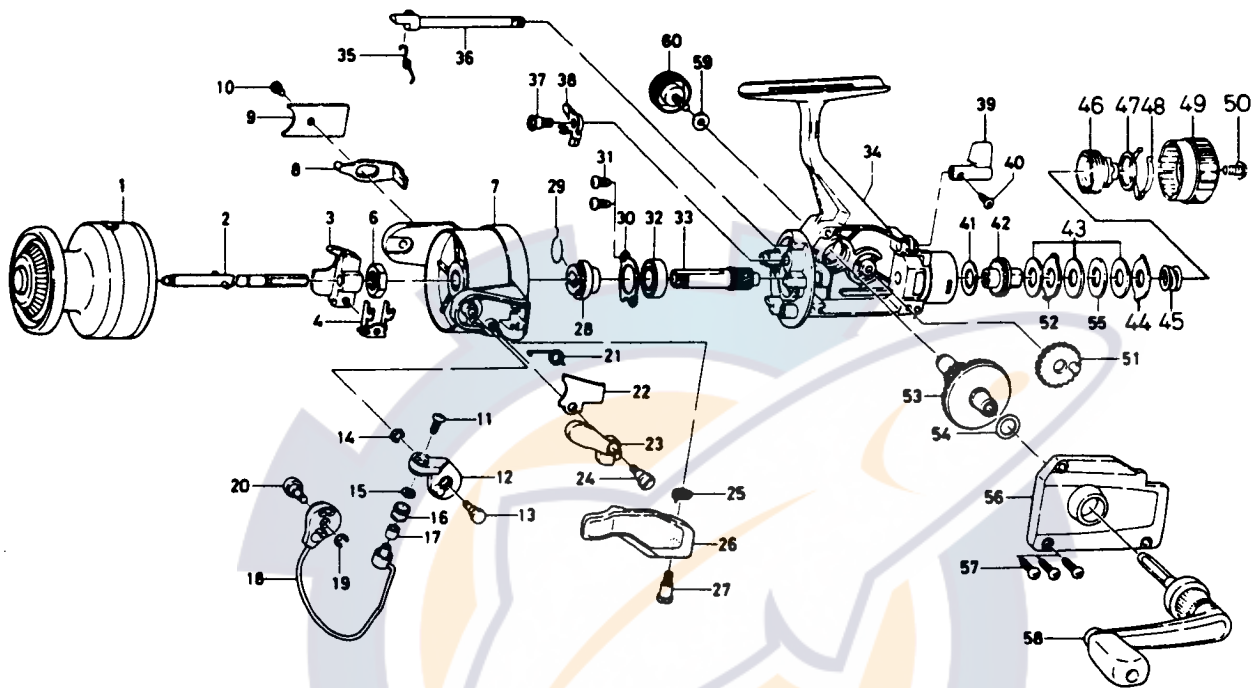

Key No.	Part No.	Part Name	Price
1	K09-9901	Spool	8.00
2	K02-4901	Main shaft	1.10
3	B97-9601	Oscillating slider	.70
4	K02-5101	Oscillating slider retainer	.85
6	B67-9401	Rotor nut	.50
7	B87-8505	Rotor	5.50
8	B83-5701	Bail trip lever	1.20
9	B74-7301	Bail trip cover	.60
10	B83-4402	Bail trip cover screw	.50
11	B67-9302	Line roller screw	.40
12	B67-4601	Bail arm	1.35
13	B83-3801	Bail arm screw	.70
14	320-5901	Bail arm screw retainer	.50
15	B55-4301	Line roller washer	.40
16	250-3921	Line roller	.90
17	B45-1501	Line roller bushing	.60
18	K10-6702	Bail	3.90
19	320-5901	Bail trip cam screw retainer	.50
20	B83-4202	Bail trip cam screw	1.25
21	K04-9701	Bail spring	.60
22	B83-3902	Bailspring cover	.55
23	B67-4901	Trigger plate	1.35
24	K03-7302	Bail spring cover screw	.90
25	B67-5201	Trigger spring	.60
26	B67-5107	Trigger lever	2.50
27	K03-7302	Trigger screw	.90
28	K02-2901	Anti-reverse ratchet	.90
29	K02-5401	Anti-reverse pawl spring	.55
30	B45-6401	Bearing retainer	.50
31	B83-4402	Bearing retainer screw	.50

Key No.	Part No.	Part Name	Price
32	634-1301	Ball bearing	6.95
33	E08-9502	Pinion gear	2.50
34	K09-9501	Body	6.60
35	B44-8501	Anti-reverse cam spring	.55
36	B44-8401	Anti-reverse cam	.70
37	K03-2801	Anti-reverse pawl screw	.55
38	K02-2701	Anti-reverse pawl	.70
39	E08-3701	Anti-reverse lever	1.20
40	B12-8201	Anti-reverse lever screw	.50
41	B48-9902	Drag washer A	.45
42	B83-3602	Click gear	.70
43	B49-0202	Drag washer B	.60
44	B49-0102	Eared washer A	.40
45	B92-6703	Drag coil spring	.55
46	B74-7603	Drag screw	.85
47	B90-8201	Drag washer C	.40
48	B74-7702	Drag washer spring	.45
49	K04-8605	Drag knob	1.55
50	352-1105	Drag knob spring screw	.55
51	B74-2501	Oscillating gear	.70
52	B63-8301	Eared washer B	.45
53	E08-9701	Drive gear	2.30
54	373-7808	Drive gear washer	.40
55	B49-0301	Key washer	.45
56	E08-4107	Side cover	2.35
57	B83-5002	Side cover screw	.60
58	E00-1603	Handle	6.60
59	B92-4902	Handle lock washer	.35
60	B92-5001	Handle lock screw	.80